

DATE DEC 4, 2014	OUTLINE DIMENSIONS 3-PHASE INDUCTION MOTOR	MODEL TYPE: AEGH
CATALOG NO. GH0/36		FRAME NO. A56

Pole	HP	KW	Hz	VOLT	Syn. Speed R. P. M
6	1/3	.24	60	230/460	1200

Ins.	Rating	Dimensions in	Approx Weight	Bearings
F	CONT.	inch	26 lbs	DE: 6204ZZ NDE: 6203ZZ

Totally Enclosed Fan Cooled
Squirrel-Cage

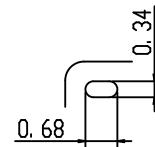
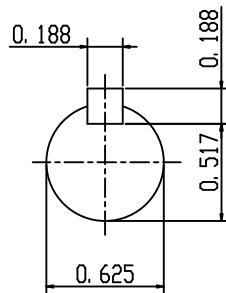
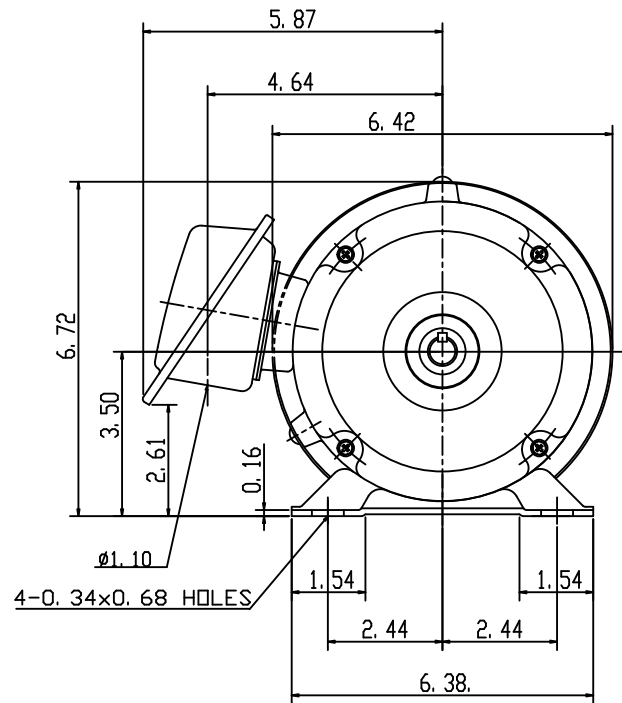
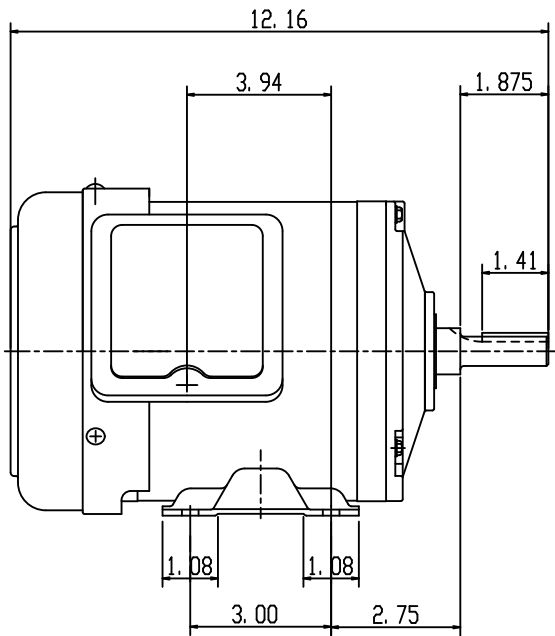

SCALE 4: 1

APPD.	W. H. TSAI	07 21 03	TECO Westinghouse	DWG NO.	31049Z105
CHKD.	J. B. CHEN	07 20 03		2204	
DWN.	Y. Y. CHEN	07 20 03			